

The RFL2-LED40 is a sleek, ruggedly designed, high efficiency floodlight. This LED flood has multiple mounting options and accessories to suit a wide range of applications.



Cover plate not included.

APPLICATIONS

Ideal for building façades, sign lighting and wall washing in both commercial and industrial applications.

Project	
Type	
Date	
Notes	

SPECIFICATIONS

Construction

Precision die cast aluminum housing with clear tempered glass lens. Superior heat sink design with air-flow fins on the top and bottom to maximize fixture life.

LED configuration

Each unit has two high efficiency Chips on Board (COBs) that delivers 4,600 lumens. The LEDs have a color temperature of 5,000K as standard. 4000K, 3000K also available. The CRI is greater than 70 and the operating temperature range is -40°C to +40°C.

Beam Distribution

NEMA 7H X 6V (wide) is standard. NEMA 3H X 3V (narrow) is available as an option.

Electrical

Total system wattage of the unit is 40W. The standard unit has a high efficiency driver that operates at 120 - 277V.

Mounting

Standard unit is available with two mounting options:
- Knuckle mount - 1/2" NPT Knuckle. Round cover for 4" octagon box sold separately.
- Yoke mount - 3.64" deep yoke with watertight connector.

Finish

Standard finish is Bronze. Please consult factory for custom color.

Accessories

Visor, Polycarbonate lens, Wire Guard, Photocell, Phillips Dynadimmer. Phillips Dynamdimmer dims the fixture to 25% for 6 hours instead of operating at 100% at all times.

Input Watts	40W
Lumens	min. 4,600
Efficacy	min. 115 lumens per watt

Operating Temperature	-40°C to +40°C
Certification	cULus, IP65
Warranty	5 Years
Color Temperature	5000K (standard) 4000K (option) 3000K (option)
LED life	100,000 hours
Effective Projected Area (EPA Rating)	0.45 sq ft
Total Harmonic Distortion	10%
Power Factor	0.988

DIMENSIONS

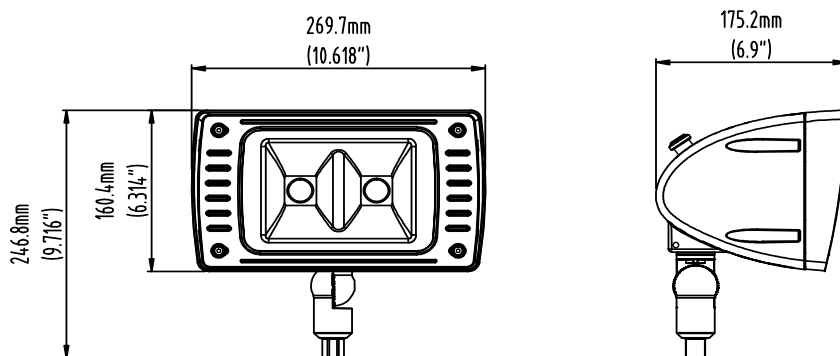

With optional Narrow beam (3X3)



MOUNTING OPTIONS

Knuckle, Yoke mount



Knuckle

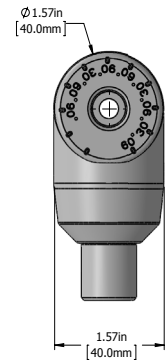
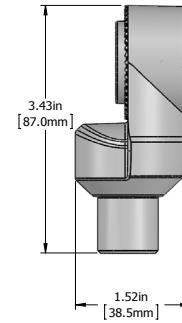
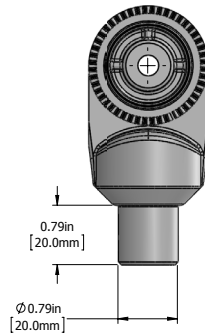

Yoke

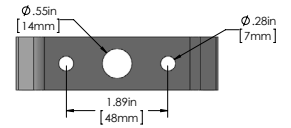
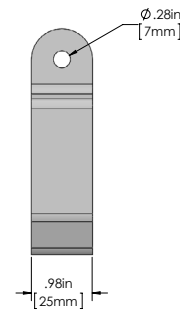
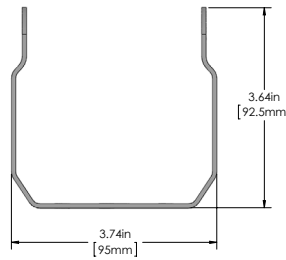

ACCESSORIES

Polycarbonate lens, Wire guard, Visor

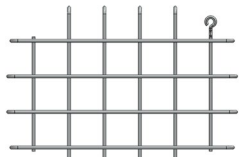
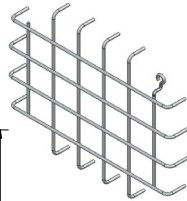
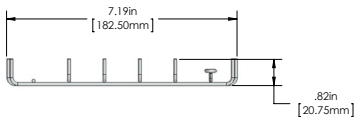

Wire Guard

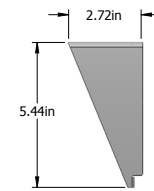
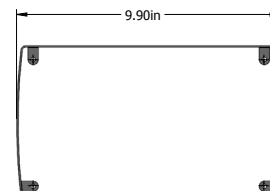
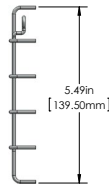

Visor

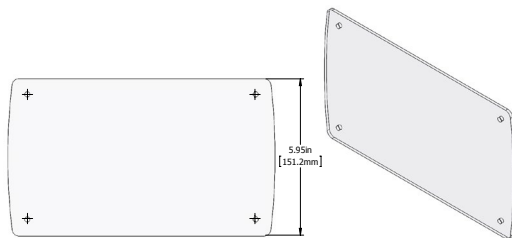
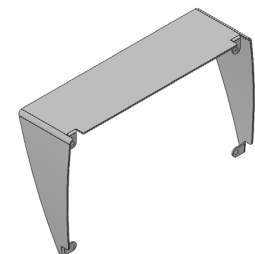

Polycarbonate Lens

ORDERING GUIDE

RFL2	LED40						
		VOLTAGE	COLOR TEMP	BEAM	FINISH	MOUNTING	OPTIONS
		B - 120 - 277V* A - 120V F - 277V	5K - 5000K* 4K - 4000K 3K - 3000K	W - Wide (7X6)* N - Narrow (3X3)	BRZ - BRONZE* CC - CUSTOM COLOR	YK - Yoke* KN - Knuckle*	V - Visor WG - Wire Guard PCL - Polycarbonate Lens PC - Photocell

* Standard configuration