

INSTALLATION INSTRUCTIONS



ELECTRICAL SHOCK HAZARD

READ, UNDERSTAND, and FOLLOW these instructions before installing the equipment.

WARNING

Disconnect the Electrical supply power at the service panel (fuse or circuit breaker box). Failure to do so could result in serious injury or death. Only qualified electricians should install this fixture and the installation **MUST** conform to the Electrical Code and all local codes and ordinances. Ensure that only proper tools, materials, and equipment are used to complete the installation.

SAFETY

- Proper grounding is required to ensure safety.
- Fixture should be mounted in locations where unauthorized personnel will not readily subject it to tampering.
- Do not use this equipment for anything other than its intended purpose.
- Servicing this equipment should be performed by qualified service personnel.
- Save these instructions.
- **MIN 75°C SUPPLY CONDUCTOR**

INSTALLATION

1. Install the (4) wall anchor screws at 10.236" (260mm) center to center distance with a width of 2-11/16" (68mm). [1]
2. Pull out the end tabs on the end cap and carefully pop off lens. [2]
3. Make appropriate wiring connections inside the junction box as per the wiring diagram. [3]
4. Align the wall anchor screws with the fixture keyholes.
5. Push/pull the fixture to lock it in place and tighten the screws.
6. Optional: Change the CCT using the CCT selectable switch found inside the fixture. Select between 3500K, 4000K, and 5000K CCT. 4000K is default. [4]
7. Attach the lens.
8. Optional: Attach the female to male 3-PIN connectors to join multiple fixtures together. (15 max) [5]

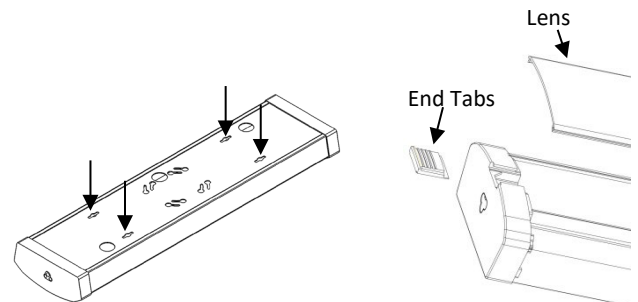

[1]

[2]

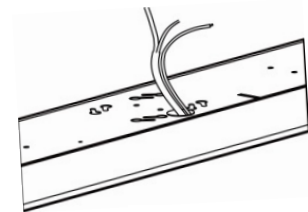

[3]

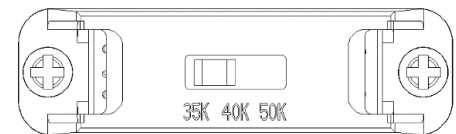

[4]

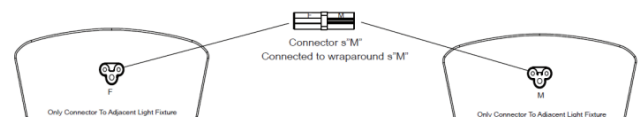

INSTALLATION INSTRUCTIONS

END CAP FOR 5-PIN DAISY-CHAINING CONNECTION OR CONDUIT ENTRY

Optional accessories sold separately

1. Remove screws and the original 3-PIN end caps from fixture. [6]
2. Disconnect the ground wire from the housing and cut the wires that are attached to the end cap. [7]
3. Attach the conduit entry end cap [8] or 5-PIN connector end cap [9] onto fixture and secure using screws.
4. Connect the wires according to the wiring diagram. See image [10] for 5-PIN connector end cap. If using the end cap with conduit entry, punch out the knocked holes for wiring.
5. Cap any unused wires.

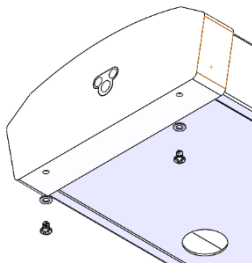

[6]

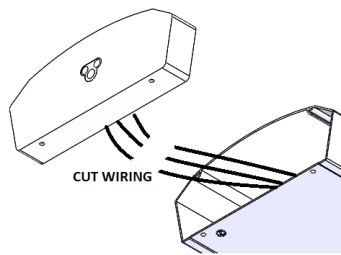

[7]

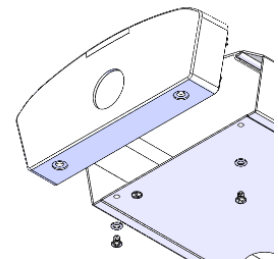

[8]

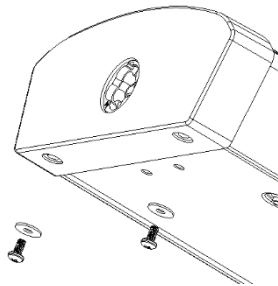

[9]

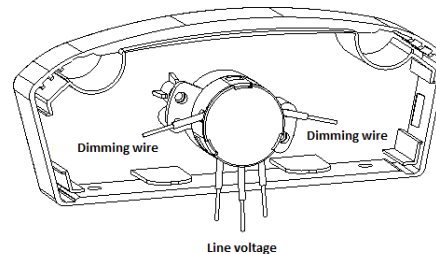

[10]

WIRING

- Check that the line voltage is correct.
- Connect fixture **GROUND** (green) wire to power supply **GROUND** (green) wire.
- Connect fixture **WHITE** wire to power supply **NEUTRAL** wire.
- Connect fixture **BLACK** wire to power supply **LINE** wire.

Optional for 0-10V Dimmable Models

The fixture includes 0-10V dimming functionality, connect GREY or PINK and VIOLET wires to a 0-10V dimming controller.

