

LFW-LED LINEAR VAPOURPROOF

INSTALLATION INSTRUCTIONS



ELECTRICAL SHOCK HAZARD

READ, UNDERSTAND, and FOLLOW these instructions before installing the equipment. **SAVE** these instructions.

WARNING

Disconnect the Electrical supply power at the service panel (fuse or circuit breaker box). Failure to do so could result in serious injury or death. Only qualified electricians should install this fixture and the installation **MUST** conform to the Canadian Electrical Code Part I and all local codes and ordinances. Ensure that only proper tools, materials, and equipment are used to complete the installation.

SAFETY

- Proper grounding is required to ensure personal safety.
- Fixture should be mounted in locations where unauthorized personnel will not readily subject it to tampering.
- Do not use this equipment for anything other than its intended purpose.
- Servicing this equipment should be performed by qualified service personnel.
- Save these instructions.
- **MIN 90 °C SUPPLY CONDUCTOR**

TOOLS REQUIRED

- Phillips Screwdriver
- Alley Keys (Various Sizes)
- Drill Tool (Optional)

INSTALLATION

Direct Mount

Note: Direct mount kit comes standard with fixture

- Attach the mounting brackets directly into the mounting surface using the hardware provided [1].
- Press the fixture into the brackets until the fixture snaps into place [2].
- Connect wires as indicated in the wiring diagram.

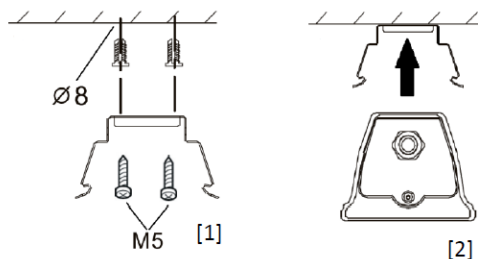

Pendant Mount

- Attach the pendant cable to the ceiling using the hardware provided.
- Connect the cable base through the mounting bracket with the nut provided [3].
- Press the fixture into the brackets until the fixture snaps into place.
- Connect wires as indicated below.

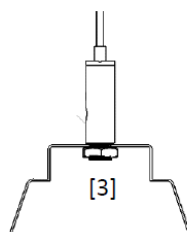

LFW-LED LINEAR VAPOURPROOF



INSTALLATION INSTRUCTIONS

Wall Mount

- Attach the smaller portion of the wall mount bracket to the fixture mounting bracket using the hardware provided [4].
- Attach the larger portion of the wall mounting bracket to the wall through the slots using the hardware provided [5].
- Connect both portions of the wall mounting bracket through the central hole and slot using the hardware provided [6].
- Adjust the angle of the bracket then tighten the screw in the slot to fix the bracket in place.
- Press the fixture into the brackets until the fixture snaps into place.
- Connect the wires as indicated in the wiring diagram.

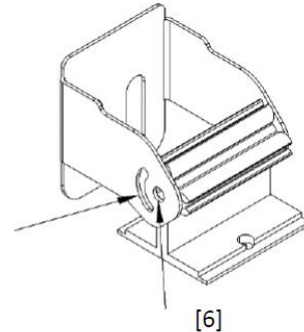
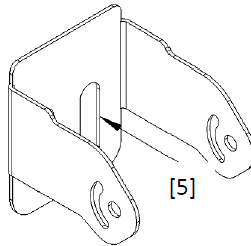
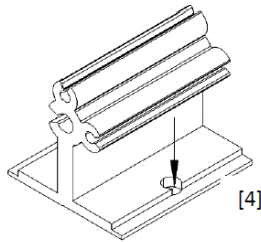

CCT SELECT SWITCH

- Remove the labeled end cap with the CCT Switch label.
- Gently pull the wiring terminal and adjust the CCT with the switch in front of the end terminal.
- Push the end terminal back into the fixture and re-attach the end cap.

WIRING

- Remove end cap and gently pull out wiring terminal [7].
- Wiring terminals are available at both ends.

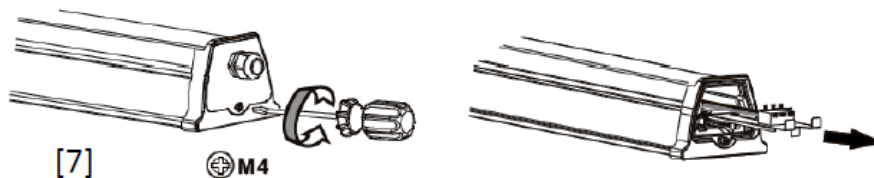

- Connect wires as indicated in the wiring diagram and in accordance with local electrical codes.
- Re-attach end cap and secure screw.
- Maximum number of fixtures that can be daisy-chained: 20 units for 40W and 10 units for 60W.

Wiring Diagram

- Check that the line voltage is correct.
- Connect fixture GROUND (green) wire to power supply GROUND (green) wire.
- Connect fixture WHITE wire to power supply NEUTRAL wire.
- Connect fixture BLACK wire to power supply LINE wire.
- The fixture includes 0-10V dimming functionality, connect PINK and VIOLET wires to a 0-10V dimming controller (optional).

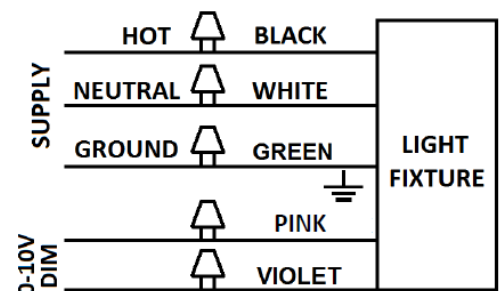

LFW-LED LINEAR VAPOURPROOF



INSTALLATION INSTRUCTIONS

MOTION SENSOR (FACTORY-INSTALLED OPTION)

- Fixtures cannot be daisy-chained with motion sensor.
- One sensor per fixture only.
- Default Settings:

	Default Setting
Brightness	100%
Sensitivity	100%
Hold Time	10sec
Stand-by Dim Level	30%
Stand-by Time	1min
Daylight Threshold	30Lux

Default Setting: If ambient light is more than 30lux, the fixture will stay off. If ambient light is less than 30 lux, after no motion for 10sec (hold time), the fixture will dim from 100% (brightness) to 30% (stand-by dim level). After no motion for another 1 min (stand-by time), the fixture will turn off.

ADJUSTING MOTION SENSOR SETTINGS USING RC-100 REMOTE CONTROL

<p>The diagram shows the RC-100 remote control with the following settings indicated by icons and text:</p> <ul style="list-style-type: none"> BRIGHTNESS: 70%, 80%, 90%, 100% SENSITIVITY: 20%, 50%, 75%, 100% HOLD TIME: 10s, 1m, 5m, 10m, 15m, 20m, 30m, 60m DAYLIGHT SENSOR: Eye icon, 10, 30, 50, 100, 300, 500 STAND-BY DIM: 0%, 10%, 30%, 50%, +∞, 1m, 30m, 60m Buttons: ON/OFF, DISP, ▲, SEND, AUTO, ◀, OK, ▶, RESET, TEST 2s, ▼, □, MODE1, MODE2, MODE3, MODE4 	<p>BRIGHTNESS: Sets the highest light fixture brightness when motion is detected.</p>
	<p>SENSITIVITY: Sets the sensitivity to which the sensor will detect motion. It describes the radii of the circular detection zone.</p>
	<p>HOLD TIME: The time the light fixture will remain at the brightness setting after it detects motion.</p>
	<p>DAYLIGHT SENSOR: The lux setting that the light fixture will turn on/off. If the ambient lux is more than the defined lux setting, the fixture & sensor function will turn off and remain off until the ambient lux is below the setting. To disable the lux sensor, select the SUN icon. To set the lux to match current room conditions, select the EYE icon.</p>
	<p>STAND-BY DIM: The Dim level that the light fixture will dim down after the Hold Time has expired. To disable dimming and only have ON/OFF, select the 0% icon.</p>
	<p>STAND-BY TIME: The time the light fixture will remain in the dim down state before it shuts off. To disable the light from shutting off, select the INFINITY icon.</p>

RC-100 REMOTE SPECIFICATIONS

Power Supply	2 x AAA 1.5V Batteries
Communication Protocol	940 nm Infrared Tx & Rx
Communication Range	Up to 15m (50ft)
Operating Temp.	0°C to 50°C

LFW-LED LINEAR VAPOURPROOF



INSTALLATION INSTRUCTIONS

RC-100 REMOTE PROGRAMMING INSTRUCTIONS

KEY	FUNCTION					
	Light fixture will be set to permanently stay ON or OFF. Must press AUTO button to go back to sensor mode.					
	Displays the current remote-control parameters.					
	Navigate through the remote-control parameters and sets them to the desired settings. NOTE: These settings are not yet set on the light fixture sensor. The remote needs to be pointed at the light fixture sensor, and the SEND button needs to be pushed.					
	Uploads the selected remote-control parameters to the light fixture sensor. The light fixture will turn on and off as confirmation the new settings have been set.					
	Light fixture sensor is set to sensor mode with the last sent parameters. This must be pressed to exit the ON/OFF setting.					
	Resets the light fixture sensor parameters.					
	Brightness	Sensitivity	Hold Time	Daylight Sensor	Stand-by Dim	Stand-by Time
	100%	100%	5 minutes	Disabled	DIM: 30%	60 minutes
	For Testing sensitivity only. The Standby period and daylight sensor are disabled in this mode. Must press AUTO button to go back to sensor mode.					
	Photocell Function: If this function is turned on, it is set to a specific lux setting (10, 30, 50, 100, 300, 500). When the lux level exceeds this setting, the sensor will wait and monitor for 1 minute to confirm the lux level is not temporary. After 1 minute, the lights will turn off even when the space is occupied. When the lux level goes below this setting, the light will turn on and remain on without any detected motion. This feature is disabled by default and is intended for outdoor use only.					
	Four modes are available with pre-set parameters. Any mode can be customized by following the steps below: 1. Select mode 1, 2, 3, or 4. 2. press the ARROW BUTTONS to choose the new parameters. 3. Select OK to confirm the new settings on that mode. NOTE: These settings are not yet set on the light fixture sensor. The remote needs to be pointed at the light fixture sensor, and the SEND button needs to be pushed. NOTE: Modes 2, 3, and 4 all have the same default settings. See instructions to change defaults.					
Mode Default Settings	Brightness	Sensitivity	Hold Time	Daylight Sensor	Stand-by Dim	Stand-by Time
	100%	100%	5 minutes	Disabled	30%	Disabled
	70%	20%	10 seconds	Disabled	0%	Disabled