



SL2-LED20

LED Strip Light

SPECIFICATIONS

Watts	20 W
Lumens	2472 lm
Efficacy	122.7 Lm/W
Replaces Up To	2 Lamp T8 17W
Colour Temp**	Selectable - 3K, 4K, 5K
Certification	cULus, IP20
Operating Temp	-30°C to +40°C
Voltage	120-277V*
LED Life (L70)	>100,000 hours
Housing Material	Steel
Lens Material	Polycarbonate
Lens Type	Frosted
Mounting	Surface mount, suspended mount using linear ceiling pendant mount kit.
Total Harmonic Distortion	4.3%
Power Factor	0.99
CRI	80
Internal Surge Protection	2KV
Weight	2.8 lbs

**Colour temperature is selectable and can be adjusted on the fixture through a switch. The default switch setting is set to 4K on the fixture.



DESCRIPTION

The SL2-LED20 strip light provides a highly efficient lumen output of approx. 2400 lumens ideal for replacing 2 Lamp T8 17W fixtures. The frosted linear lens provides uniform light distribution ideal for use in shops, coves and general area lighting.

APPLICATIONS



Shops



Cove Lighting



General Area Lighting

FEATURES

- Fixture can be set at a color temperature of 3000K, 4000K or 5000K while installing through a switch inside the housing
- Narrow, linear design with frosted lens for uniform light distribution
- Join up to 35 fixtures on a single circuit using easy connector steel plates. Fixtures are daisy chained with line wires fished through the housing continuous row.
- Options: dimming high frequency sensor (inside housing), wire cage, reflector wings, linear ceiling pendant mount kit

DIMENSIONS

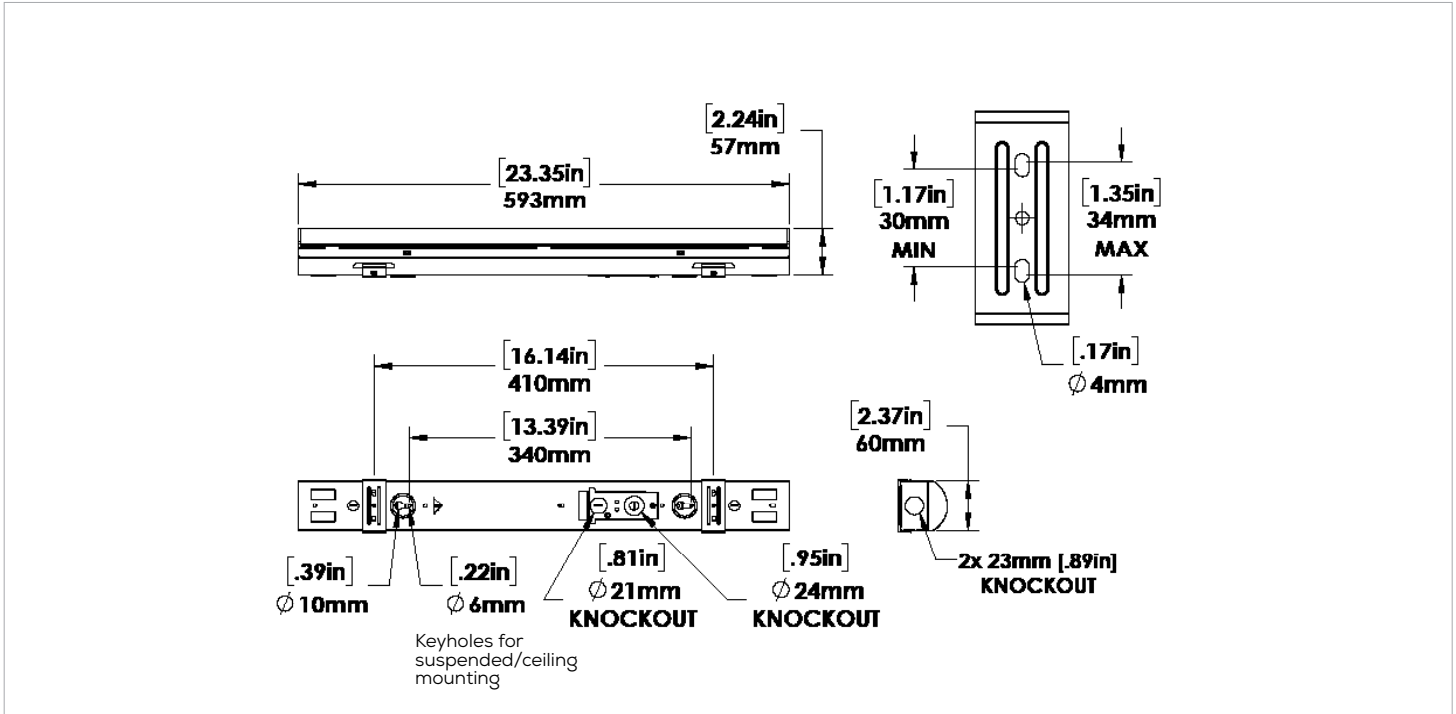

COLOR SELECTABLE SWITCH

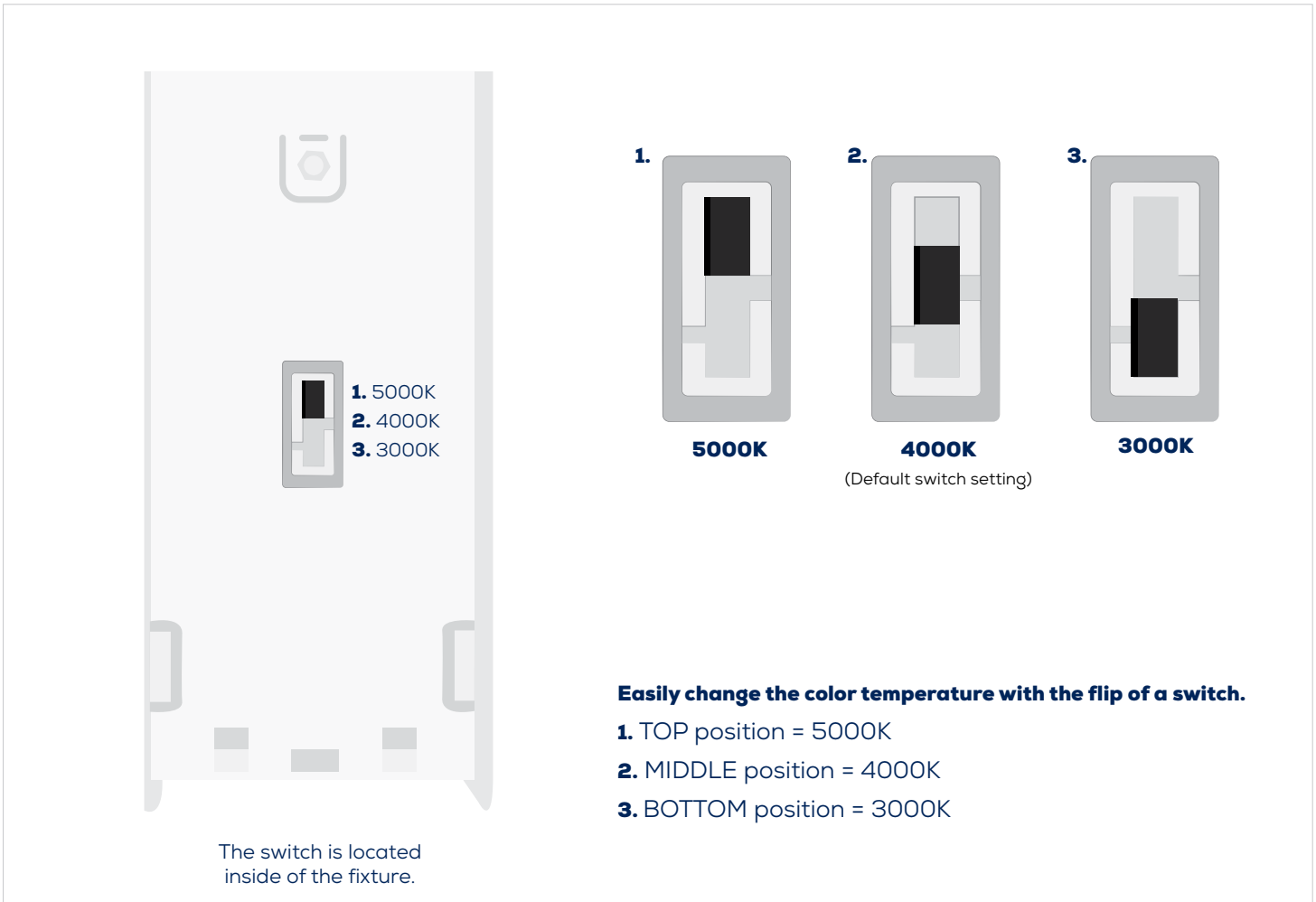

LINEAR CEILING PENDANT MOUNT KIT

Linear Ceiling Pendant Mount Kit

Contains 2 x 5 foot aircraft cables with ceiling mounting plates, fixture mounting rod and nut, 6 drywall anchors, and 6 screws.

SKU 051331



REFLECTOR WINGS

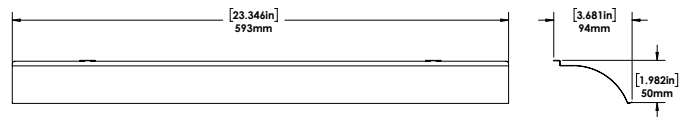

Reflector Wings Kit - Wings attach by inserting tabs into the cutouts on the fixture
SKU 051574

WIRE CAGE

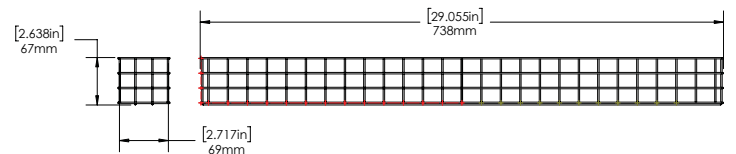

Fixture shown with wire cage

Wire Cage - To install, place wire cage over the fixture and screw the clips on to the mounting surface.
SKU 051575

End caps of the wire cage are removable which allows installer to connect multiple fixtures with wire cages seamlessly. To connect two wire cages together, order the hardware kit 052956.

SL2-LED20-B-4K-DIM(SL2-LED20-B-VK-DIM
MOUNTED AT 8 FEET

Total Lumens = 2448

Mounting Height = 8 Ft

Maximum Calculated Value = 11.55 Fc

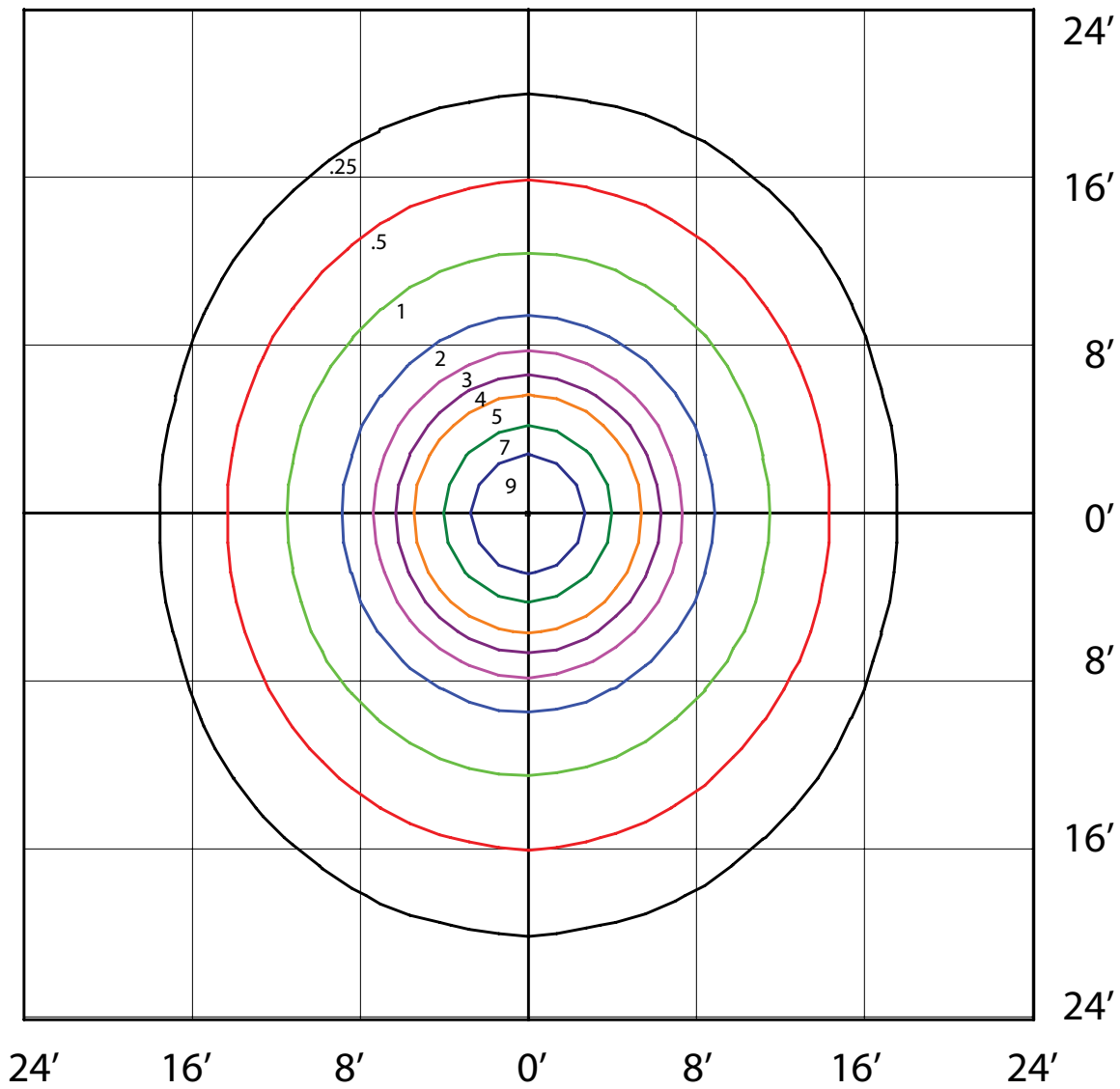

DHFS MOTION SENSOR

Dimming High Frequency Motion Sensor is factory installed.

RC100 REMOTE

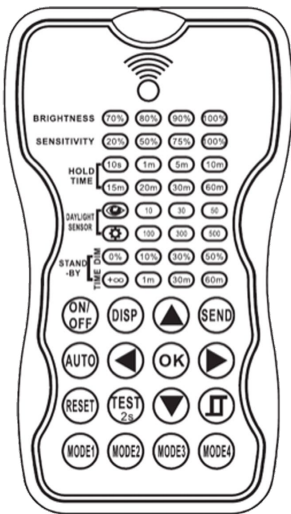

** Required additional purchase for custom configurations

DEFAULT SENSOR SETTINGS					
BRIGHTNESS	SENSITIVITY	HOLD TIME	DAYLIGHT SENSOR	STAND-BY DIM	STAND-BY TIME
100%	100%	5 minutes	Disabled	DIM: 30%	60 minutes

DHFS SENSOR SPECIFICATIONS	
POWER SUPPLY	100-277 VAC, SINGLE PHASE, 60HZ 100-347 VAC, SINGLE PHASE, 60HZ 208/230/480 VAC, PHASE TO PHASE, 60HZ
MAXIMUM LOAD	100-120 VAC, 800W, TUNGSTEN 100-120 VAC, 800W, ELECTRONIC BALLAST/LED DRIVER 230-240 VAC, 300W, ELECTRONIC BALLAST/LED DRIVER 277 VAC, 1200W, ELECTRONIC BALLAST/LED DRIVER 347 VAC, 1200W, ELECTRONIC BALLAST/LED DRIVER 480 VAC, 480W, ELECTRONIC BALLAST/LED DRIVER
HIGH FREQUENCY SYSTEM	5.8GHZ +/-75MHZ
DIM CONTROL OUTPUT	0-10V DC DIMMING, 25MA
DETECTION RADIUS/ANGLE	MAX 8M (26FT) AT 360°
MOUNTING HEIGHT	MAX 6M (20FT)
HUMIDITY	MAX 95% RELATIVE HUMIDITY
OPERATING TEMP.	-40°C TO +70°C
CYCLES	200,000 ON/OFF CYCLES
CERTIFICATIONS	cRUus, FCC
PROGRAMMING	WIRELESS PROGRAMMING USING RC-100 REMOTE

DHFS DETECTION RANGE & RADIUS/ANGLE

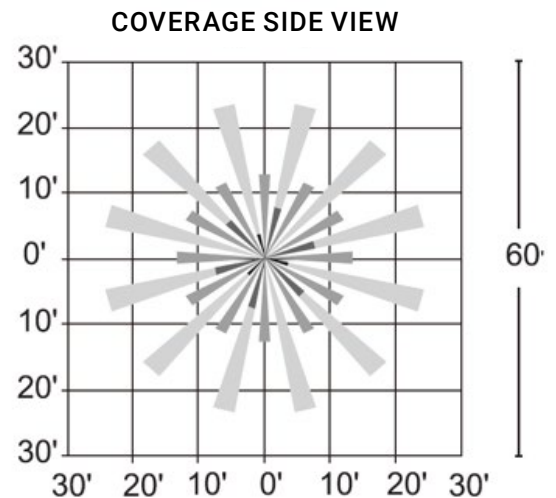
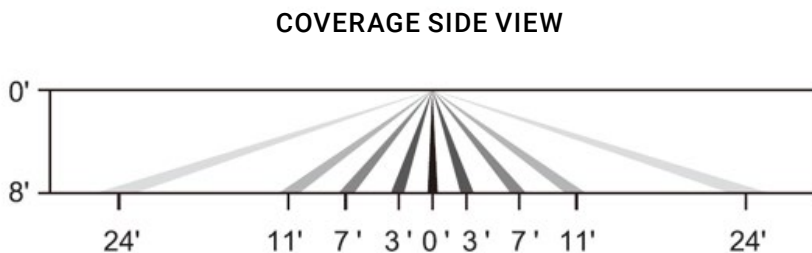

ORDERING GUIDE

SL2	LED20	B	VK	DIM	
WATTS	VOLTAGE	COLOR TEMP.	DRIVER	OPTIONS	
	B - 120-V*	VK - COLOR SELECTABLE* (can be adjusted to 3K, 4K, or 5K)	DIM - 0-10V Dimming*	DHFS – Dimming High Frequency Sensor (factory installed inside the housing)	

*Standard Configuration.

FIELD INSTALLED ACCESSORIES

CHECK THE ACCESSORIES YOU WISH TO ORDER:

051575 SL2-LED WIRE CAGE

052956 - SLX-LED/SLH4-LED WIRE CAGE HARDWARE KIT FOR CONTINUOUS ROW*

051574 SL2-LED REFLECTOR WINGS KIT - WHT

051331 LINEAR CEILING PENDANT MOUNT KIT

*052956 is a hardware kit for connecting 2 wire cages