



WL1S-LED30

Wall Light LED



IDEAL APPLICATIONS

- ✓ Townhouses
- ✓ Strip Malls
- ✓ Entrances/Exits
- ✓ Building Perimeters
- ✓ Man Doors
- ✓ Loading Areas

DESCRIPTION:

The WL1S-LED30 is a compact, easy-to-install, CCT selectable LED wall light that has an integrated photocell for dusk to dawn operation.

FEATURES:

- Clear, ribbed polycarbonate lens that creates a soft, uniform spread of light.
- Modern appearance with bronze powder coat finish
- Quick and Easy to install - Fixture can be hung on to the screw on the back box allowing Installer to use both hands for wiring.
- Once wiring is complete, hook the front housing to the back box and complete installation by fastening the screw at the bottom.
- CCT Select Unit - Choose between 3000K/4000K/5000K using a switch inside the housing.
- Electronic photocell included with fixture for dusk to dawn operation. Photocell can be disconnected during installation if needed.
- Three 1/2" NPS conduit entries (1 on each side, and 1 at the back)
- Ideal for mounting heights of 7' - 20'.
- Ideal replacement for 100W Metal Halide / 70W High Pressure Sodium fixtures.

SPECIFICATIONS*

	WL1S-LED30
Power	28.24 W
Lumens	3888 lm
Efficacy	129.1 lm/W
Voltage	120-277V
CCT	Variable Kelvin (3000K/4000K/5000K)
CRI	83.2
Dimming	1-10V Dim (10%-100%)
Power Factor	0.99
LED Life (L77)	100,000 Hours
THD	9.3%
Housing Finish	Bronze
Housing Details	Die Cast Aluminum
Lens Details	Polycarbonate
Mounting	Wall mount
# Conduit Entries	Three 1/2" NPS
Operating Temp.	-40°C to +40°C (-40°F to 104°F)
B-U-G	B1-U3-G2
Certifications Logos	Wet Locations, IP65, UL, DLC Premium

* Specs shown are for 120V/4000K



DIMENSIONS:

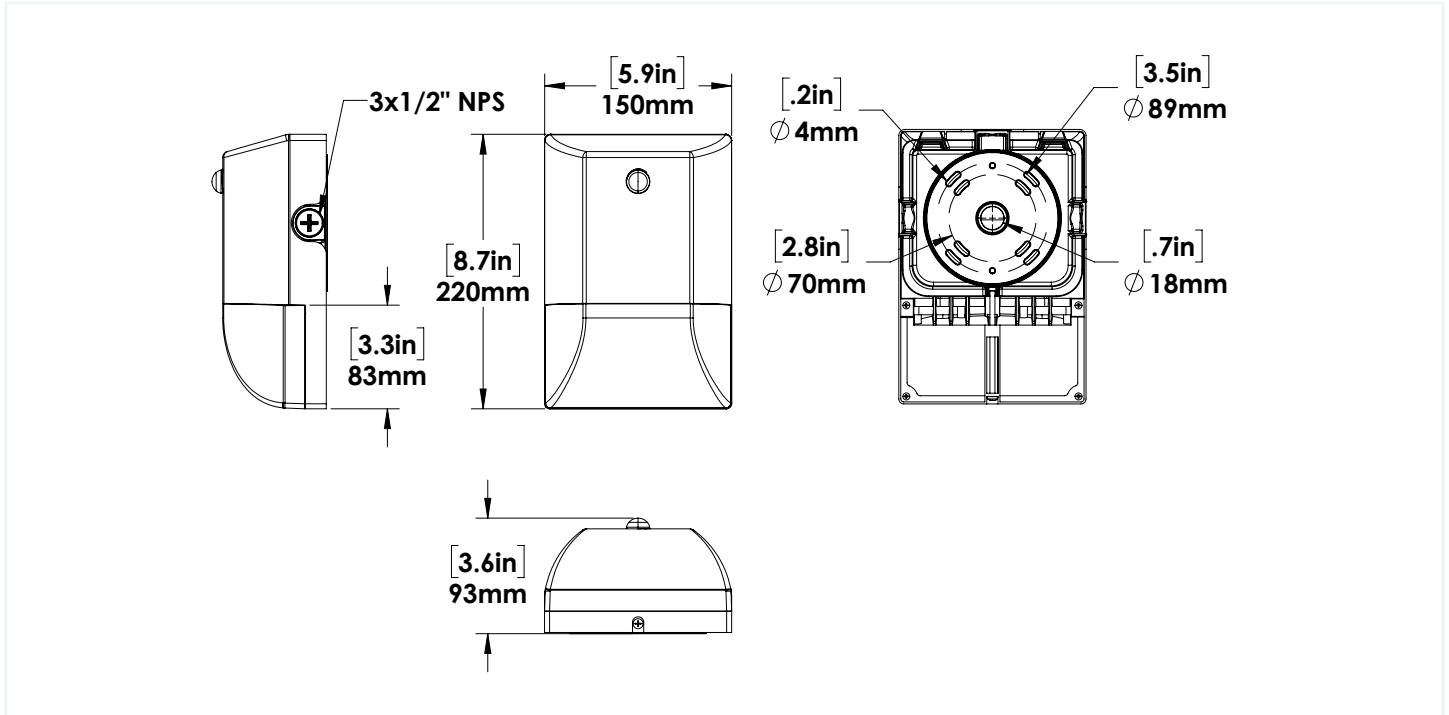

AMPERAGE DRAW & SURGE PROTECTION

	CURRENT (A)				SURGE PROTECTION (kV)
	120V	208V	240V	277V	120-277V
WL1S-LED	0.25A	0.15A	0.13A	0.11A	2kV

TM-21 ESTIMATED LUMEN MAINTENANCE

	50,000 Hours	75,000 Hours	100,000 Hours
WL1S-LED	87.8%	82.0%	76.7%

Life hours are derived from IESNA LM-80 testing report and projected per IESNA TM-21 calculations.

SPECIFICATIONS

Model Number	Voltage (V)	Power (W)	Light Output (lm)	Efficacy (lm/W)	THD (%)	PF	CCT (K)
WL1S-LED30-B-VK-BRZ-DIM-PC-CL(3000K)	120-277	29	3592	123.1	9.8	0.995	3000
WL1S-LED30-B-VK-BRZ-DIM-PC-CL(4000K)	120-277	29	3888	129.1	9.8	0.995	4000
WL1S-LED30-B-VK-BRZ-DIM-PC-CL(5000K)	120-277	29	3860	131.0	9.8	0.995	5000

EASY INSTALLATION

Easy Installation - Pre-fastened screw to secure the housing while wiring, contractor friendly



CCT SELECTABLE SWITCH

Adjustable Kelvin switch - Located inside of the fixture housing. Choose between 3000K/4000K/5000K. Default setting is 4000K

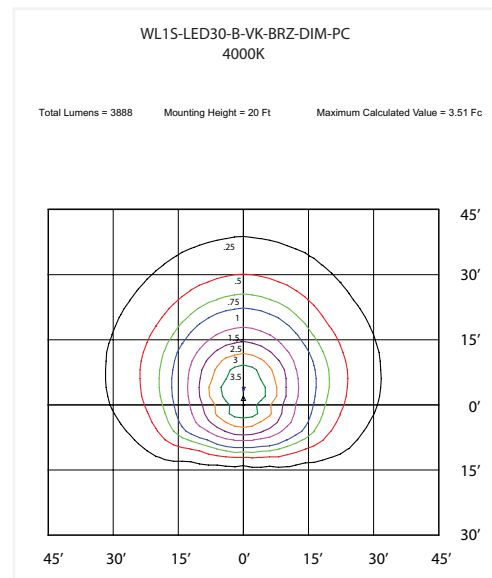
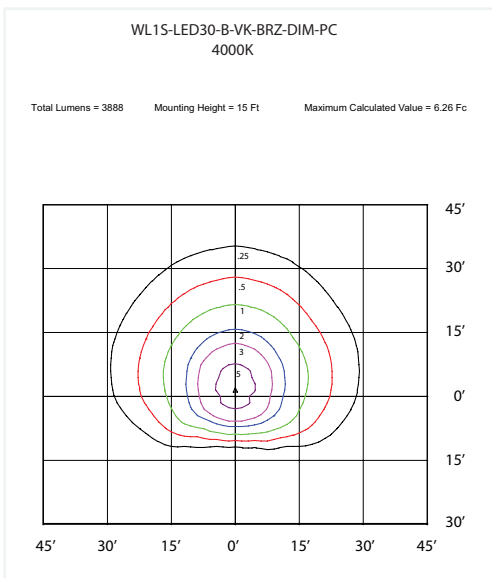
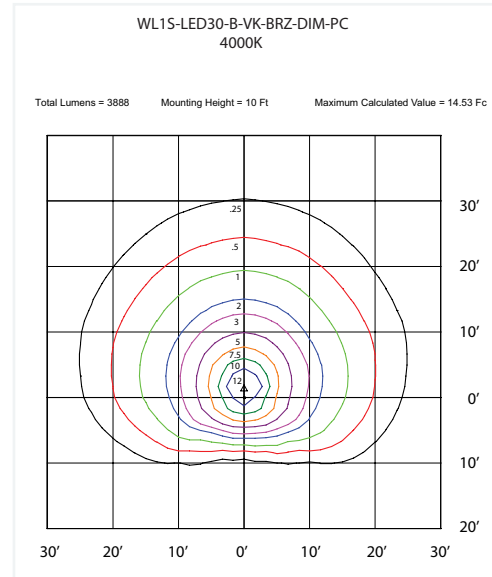
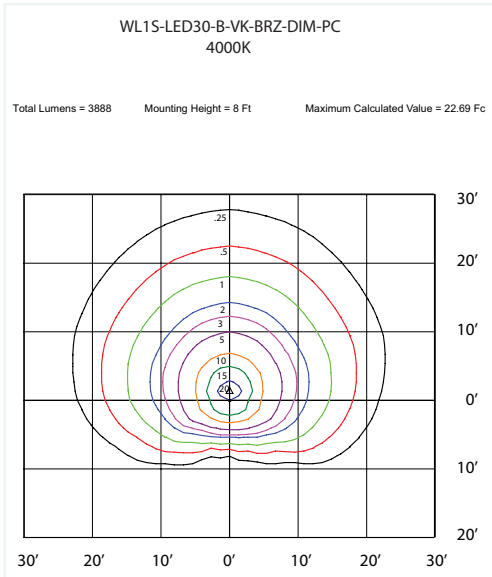
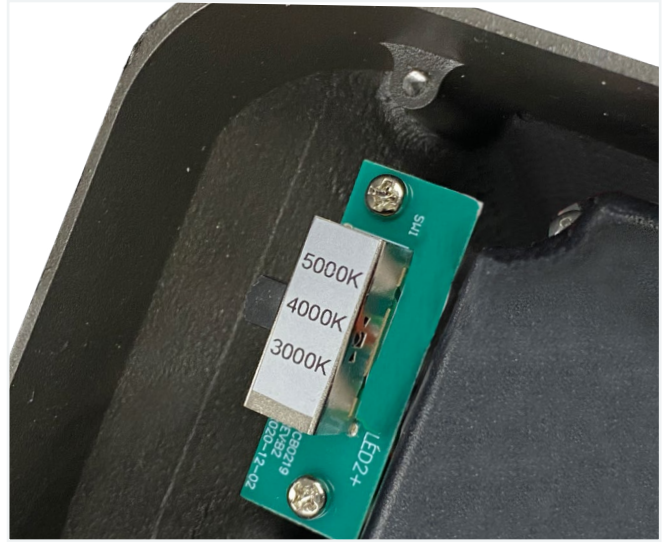

ORDERING GUIDE:

WL1S	LED30	B	VK	BRZ	DIM	PC	CL
Fixture	Wattage	Voltage	Colour Temp.	Finish	Dimming	Controls	Lens
	LED30	B - 120-277V	VK - Colour Selectable (3000K/4000K/5000K)	BRZ - Bronze	DIM - 1-10V Dimming	PC - Photocell	CL - Clear Lens

STOCK CODE	DESCRIPTION
052572	WL1S-LED30-B-VK-BRZ-DIM-PC-CL

Note: PC can be disabled by unplugging the driver wires from PC.